

Installation and operating instructions

wAppLoxx Pro

WLX Pro Access and Intrusion

WLX Pro Oval

WLX Pro Rokoko

Contents

General	3
Technical data	5
Installing the wAppLoxx Pro Cylinder	6
wAppLoxx Pro oval cylinder individual parts.....	6
Operating the wAppLoxx Pro, reader outside.....	7
Operating the wAppLoxx Pro Rokoko	9
Logging the wAppLoxx Pro Cylinder into and out of the wAppLoxx Control	12
Operating the wAppLoxx Pro Cylinder	13

General

This product complies with current domestic and European regulations. Conformity has been certified, and all related certifications are available from the manufacturer on request. To ensure the condition of this product is maintained and that safe operation is guaranteed, these operating instructions must be observed. No part of the product may be changed or modified in any way.



ABUS Security-Center GmbH & Co. KG shall not be held liable for loss or damage caused – or alleged to have been caused – either directly or indirectly by this manual. We reserve the right to make changes to this manual without prior notice.

ABUS Security-Center hereby declares that the radio system type 505272 and all WLX Pro cylinders comply with RED Directive 2014/53/EU. The full EU Declaration of Conformity text can be found at:

<https://www.abus.com/ger/Objektsicherheit/Zutrittskontrolle/wAppLoxxPro>

Safety information

Explanation of symbols:

	The triangular warning symbol indicates important notes in this user guide which must be observed.
	The triangular high voltage symbol is used to warn of the risk of injury or health hazards (e.g. caused by electric shock).
	This symbol indicates special tips and notes on the operation of the unit.

Information on the wireless range:



It is essential to check whether there is an adequate wireless connection prior to installation and commissioning.

Information on the battery:

The wAppLoxx Pro Cylinder is powered with direct current via a 3 V CR2 lithium battery that is included in the scope of delivery.



In order to ensure a long lifespan and to prevent fire and injury, comply with the following instructions:

- When inserting the battery, ensure the polarity is correct.
- Batteries must not be exposed to direct sunlight or other heat sources or stored in places exposed to very high temperatures.
- Keep batteries away from children.
- Batteries are not rechargeable.
- Batteries must not be dismantled, pierced or otherwise damaged. They must not be burned, come into contact with water or be short-circuited.
- When replacing the batteries, the respective temperature specifications of the manufacturer must be observed



To ensure a long lifespan and safe operation, you must use the following high-quality batteries:

VARTA CR2 / CR17355 3 V lithium battery



If you do not use a Varta CR2 battery, the specified lifespan cannot be guaranteed and it is not possible to ensure that the battery warning display of the WLX Pro Control will be correctly displayed.

Technical data

Cylinder variants:	WLX Pro Nordic, reader outside WLX Pro Nordic Rokoko
Scope of delivery:	Double knob cylinder, quick guide, 3 V CR2 lithium battery, forend screw
Required accessories:	ABUS Mifare DESfire EV1 Tag, WLX Pro Tool Set, small (battery replacement)
Optional accessories:	WLX card reader
Tags:	ABUS Mifare DESfire EV1 Tag 4-byte/7-byte Mifare Classic tags (we accept no liability for the use of other tags)
Configuration:	Via wAppLoxx Pro Control
Power supply:	3 V CR2 lithium battery
Conditions of use:	-25 °C to +65 °C
Drilling protection	Standard, Security
IP protection class:	IP 67
Outer knob dimensions:	Diameter 38 mm, length 48 mm
Material:	Knob: stainless steel, reading cap: plastic
Outer knob colour variants:	black, white, grey
Delivery status:	Coupled (Decoupling is not carried out until it has been successfully programmed into the wAppLoxx Pro Control)
Functions:	Opening period can be set to 6 or 12 seconds Tag reader Remote access

Installing the wAppLoxx Pro Cylinder

wAppLoxx Pro oval cylinder individual parts

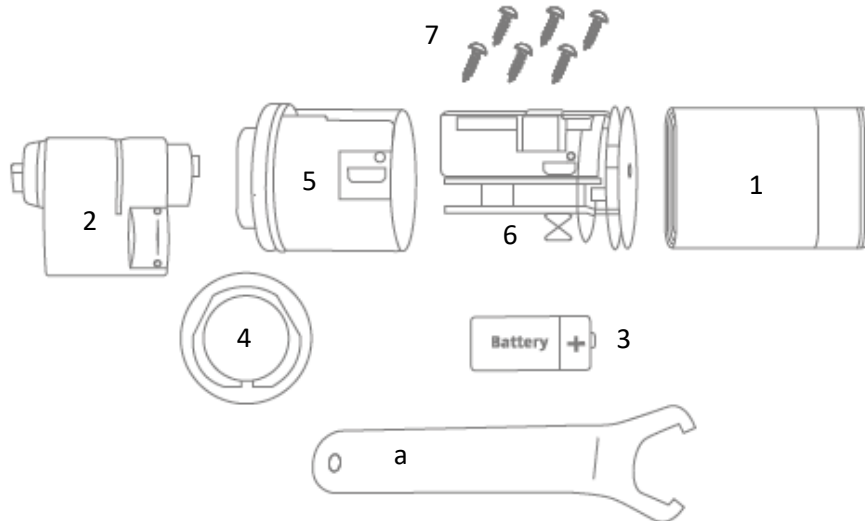

1. Outer cap
2. WLX Pro cylinder body oval
3. Battery
4. Mounting plate
5. Basket
6. PCB bracket
7. Electronic screws

Tools required (must be ordered separately):

- a. Outer cap opening key

Operating the wAppLoxx Pro, reader outside

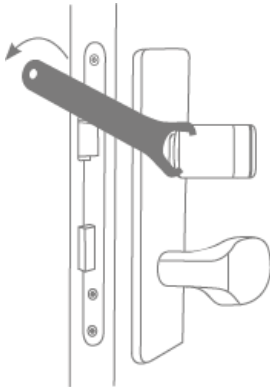

Removing the outer cap 1

The outer cap (1) has to be removed in order to insert the battery (3). Using the opening key (a), fix the mounting plate (4) onto its notch and unscrew the outer cap (1).

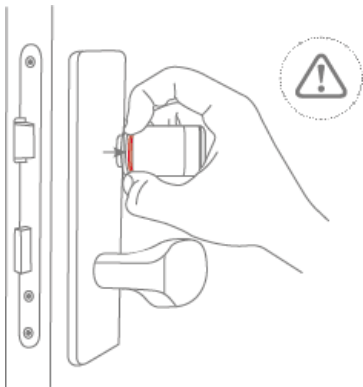

Removing the outer cap 2

The sealing ring (marked red) of the knob is located just behind the mounting plate.

Carefully pull the outer cap over the sealing ring using your fingers and stop briefly.

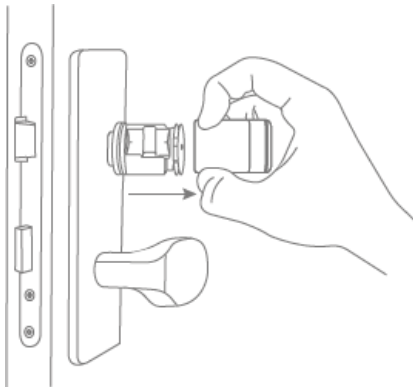

Removing the outer cap 3

Once you have pulled the outer cap over the sealing ring, the outer cap can be completely pulled off the knob.



Make sure that you pull the knob out straight. If not, you risk ripping off the circuit board

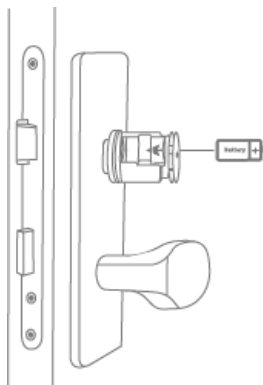

Inserting the battery

Make sure that the battery (2) is placed on the white battery flag. When inserting the battery, ensure the polarity is correct (positive terminal facing antenna circuit board).

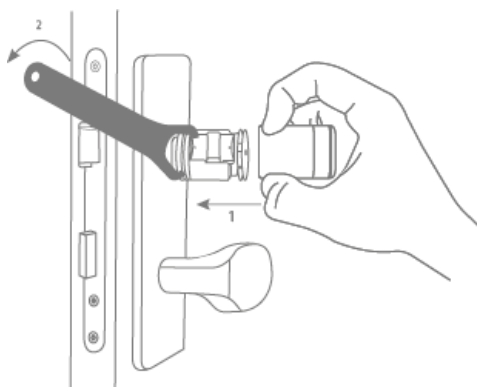

Installing the outer cap

Screw the outer cap (1) back on by securing the mounting plate using the opening key (e).



There is a marking on the outer cap that makes it easier to position the outer cap correctly on the groove of the knob.



When installing the outer cap, it is essential to ensure that the orange O-ring lies flush between the mounting plate and the knob.

Operating the wAppLoxx Pro Rokoko

Removing the outer knob 1

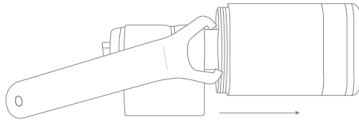

The entire outer knob (1+5+6) must be removed in order to insert the wAppLoxx Pro into the lock from the inside. Firstly, remove the outer cap (1)

Removing the electronic knob 1

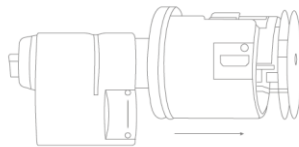

After removing the outer cap, the electronic knob (5+6) must be removed. After this, remove the PCB bracket (6) from the basket (5) and remove the basket (5) from the shaft including the mounting plate (4).

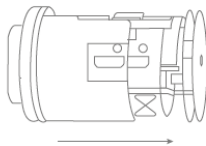

Installing the cylinder body

Once the outer knob has been removed, the cylinder body (2) can be mounted in the lock.

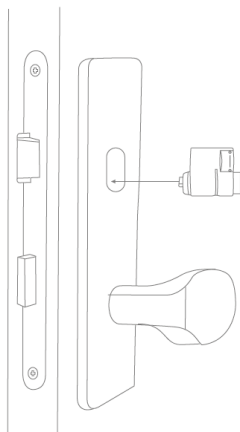

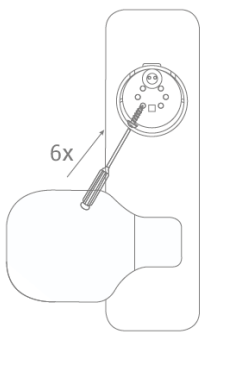

Installing the basket

When the cylinder body has been installed in the lock, secure the basket (5) to the shaft (7) using 6 screws.

During installation, make sure that the mounting plate (4) between the basket (5) and the shaft is inserted in the correct order.



In order to ensure that the cylinder is tight, it must be ensured that sufficient screw glue is applied to the electronic screws.

Installing the PCB bracket

Place the PCB bracket (6) in the basket (5) and secure using two small electronic screws.

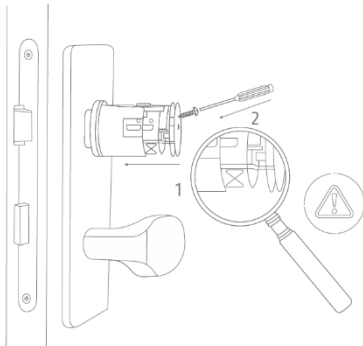

When inserting the bracket, ensure that the EMC contact is not bent (see figure on the left).

Inserting the battery

Make sure that the battery (3s) is placed on the white battery flag. When inserting the battery, ensure the polarity is correct (positive terminal facing antenna circuit board).

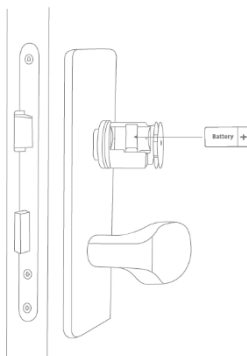

Installing the outer cap

Screw the outer cap (1) back on by securing the mounting plate (4) using the opening key (e).

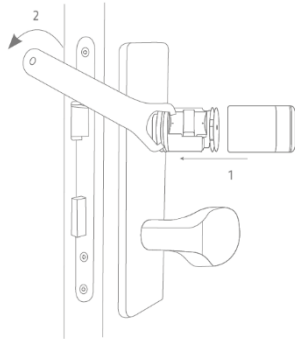

There is a marking on the outer cap (1) that makes it easier to position the outer cap correctly on the groove of the knob (3).



When installing the outer cap, it is essential to ensure that the orange O-ring lies flush between the mounting plate (4) and the knob (3).

Logging the wAppLoxx Pro Cylinder into and out of the wAppLoxx Control



Logging a wAppLoxx Pro Cylinder in:

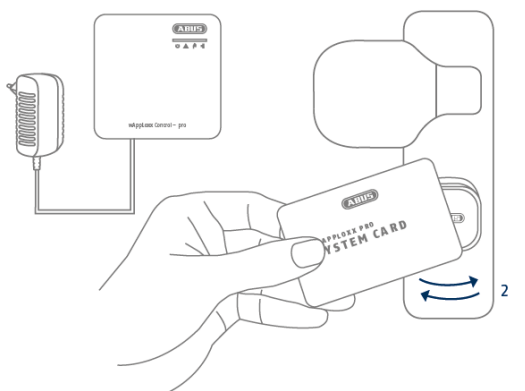

Create a new wAppLoxx Cylinder via the wAppLoxx Control Pro user interface and click on “Register” – for more information, please see the user guide of the wAppLoxx Control Pro. Now hold the wAppLoxx Pro System Card in front of the cylinder to be registered.

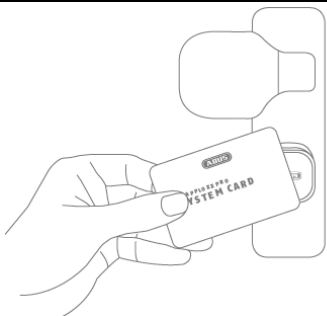

Logging a wAppLoxx Pro Cylinder out

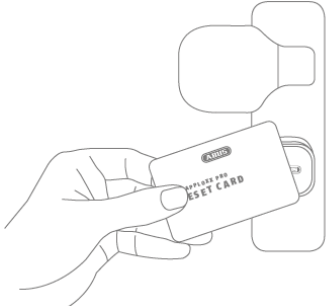
In order to log a cylinder out of the WLX Pro system, proceed as follows.

	<p>Hold the wAppLoxx Pro System Card in front of the cylinder to be logged out.</p>
 <p>10 x red</p>	<p>A flashing red signal will come on.</p>
	<p>While this flashing red signal is on, you must hold the WLX Pro Reset Card in front of the cylinder to be deregistered.</p>

 1 x green	<p>When the cylinder has recognised the reset card, it will flash green briefly.</p>
 1 x green	<p>Once the cylinder has been successfully logged out, the cylinder will light up green and return to its original state.</p>





Both cards are included in the scope of delivery of the wAppLoxx Pro Control

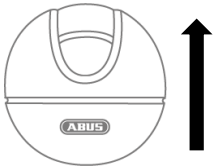

Operating the wAppLoxx Pro Cylinder

 1 x green	<p>A brief green flash signals that the tag is being read and sent.</p>
--	---

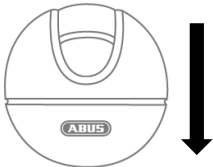

Unlocking/opening/locking:

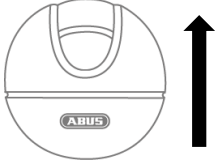

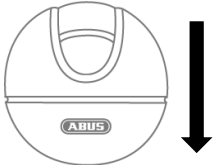
	<p>1. Present a valid tag to the reader.</p>
 2 x green	<p>2. After presenting the tag: 2 x rapid green flashes.</p>
	<p>3. Remove tag. The system is coupled for 6 or 12 seconds. The door lock is actuated with the outer knob.</p>

Disarming:

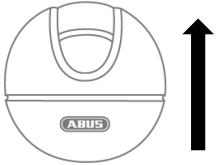

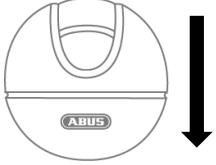
	<p>1. Present a valid tag to the reader.</p>
 <p>1 × green</p>	<p>2. After presenting the tag: 1 × green flash.</p>
	<p>3. Remove tag. The system is coupled for 6 or 12 seconds. The door lock is actuated with the outer knob.</p>

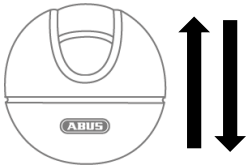
Arming:



	<p>1. Present a valid tag to the reader.</p>
 <p>2 × green</p>	<p>2. After presenting the tag: 2 × rapid green flashes.</p>
	<p>3. Remove tag. The system is coupled for 6 or 12 seconds. The door lock is actuated with the outer knob.</p>

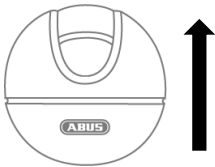

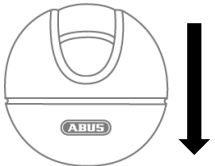



	<p>4. Present the tag to the reader again while coupled and then remove it.</p>
 <p>1 x red</p>	<p>5. The cylinder acknowledges the successful arming process with a red light.</p>

Using the fallback tag:





	<p>1. Present a valid fallback tag to the reader.</p>
 <p>1 x red, 2 x green</p>	<p>2. After presenting the tag: rapid red and green flashing.</p>
	<p>3. Remove tag.</p> <p>Repeat process twice. The system is coupled for 6 or 12 seconds. The door lock is actuated with the outer knob.</p>

Possible acknowledgements of the wAppLoxx Pro Cylinder:



 <p>2 x green</p>	<p>Access</p>
 <p>3 x red</p>	<p>Access denied</p>

 1 x red	System is armed
 1 x green	System is disarmed
 3 x red, 2 x green	Battery Warning
 1 x red, 2 x green	Authorised fallback transponder was presented
 4 x red	Unauthorised fallback transponder was presented
 1 x red	No wireless connection to the wAppLoxx Control
 6 x red	<p>The wAppLoxx Control is not ready for arming</p> <p>The wAppLoxx Control Pro is not ready for disarming</p> <p>The wAppLoxx Control receives no feedback from the alarm panel</p>

Possible acknowledgements of the wAppLoxx Pro Cylinder login/logout process:

 2 x green	Login successful
 3 x red	Logout successful
 1 x red	Login failed
 10 x red	Fallback tag/reset card required to log out

Possible acknowledgements of the wAppLoxx Pro Cylinder initialisation:

 2 x red	Communication with the outer knob possible
 2 x green	Communication with the wAppLoxx Control Pro possible
 1 x green, 1 x red, 1 x green 1 x red	Initialisation of WLX Pro

Disposal



Devices displaying this symbol may not be disposed of with domestic waste. At the end of its lifespan, dispose of the product according to the applicable legal requirements.

Please contact your dealer or dispose of the products at the
[REDACTED] local collection point for electronic waste.

ABUS Security Center GmbH & Co. KG

Linker Kreuthweg 5

86444 Affing

If you have any technical questions, please contact your specialist dealer.